

Model PT8000

BENDING-BEAM LOAD CELL



The PT8000 is a stainless steel bending beam with a hermetically sealed welded construction to IP68 standard.

This uniquely designed sensor allows for superior bellows operation through its full measurement cycle, providing better lifelong protection and accuracy.

Design benefits can be seen clearly with a less than 0.4mm deflection at full load and a safe loading rating of 150% of the rated capacity with an ultimate load rating of 300%.

In addition to its compact footprint (common to all 8 capacities from 5kg to 500kg), this cell has a superbly designed mounting accessory selection to optimise the performance and life of the cell.

The PT8000 is an ideal selection for most industrial applications with special advantages in wash down and harsh environments.

Individually packaged and supplied with serial number traceable accuracy certificate, the PT8000 is covered by a three-year warranty.

APPLICATIONS

- Weighing & packing machines
- Mechanical scale conversions
- Food, marine and other wash down environments

FEATURES

- Welded stainless steel enclosure
- Industry standard size and shape
- Large capacity range 5kg ~ 500kg
- Comprehensive mounting accessory packages

Specifications

Note: All specifications are a maximum, as a % (\pm) of full load, unless otherwise stated.

Nominal Capacity	5kg ~ 500kg	Safe Load	150% of Rated Capacity
Signal Output at Capacity	2mV/V \pm 0.1%	Ultimate Load	300% of Rated Capacity
Linearity Error	< 0.020% FSO	Input Impedance	415 Ω \pm 15 Ω
Non-Repeatability	< 0.010% FSO	Output Impedance	350 Ω \pm 3 Ω
Combined Error	< 0.025% FSO	Insulation Impedance	> 5000 M Ω at 100V DC
Hysteresis	< 0.020% FSO	Excitation Voltage (Recommended)	5 ~ 12V AC/DC
Creep/Zero Return (30 mins)	< 0.025% / 0.017% FSO	Excitation Voltage (Maximum)	15V AC/DC
Zero Balance	< 1.000% Capacity	Deflection at Rated Capacity	< 0.4mm
Temperature Effect on Output/10°C	< 0.010% FSO	Cable Type	4.5mm, Screened, PUR Sheath 4 Core x 0.24mm ² (24 AWG)
Temperature Effect on Zero/10°C	< 0.015% Capacity	Cable Length	3 Metres
Compensated Temperature Range	-10 ~ 40°C	Net Weight	0.45kg
Operating Temperature Range	-30 ~ 80°C	Material	Stainless Steel
Service Load	100% of Rated Capacity		

Ordering Information

MODEL	Part Number	ACCESSORIES	Part Number	Part Number	CABLES	Part Number
PT8000-5kg	80M0005S000XXX		5kg ~ 250kg	500kg	Junction box to indicator runs.	
PT8000-10kg	80M0010S000XXX	Load Button	A-LB16	A-LB16	Available by the metre.	
PT8000-20kg	80M0020S000XXX	Load Socket	A-LS20	A-LS20	10 Metres	A-4C4.5-0010
PT8000-50kg	80M0050S000XXX	Rod End	A-RE0.3125NN	N/A	50 Metres	A-4C4.5-0050
PT8000-100kg	80M0100S000XXX	Swivel Foot	A-SFM8	A-SFM8	100 Metres	A-4C4.5-0100
PT8000-200kg	80M0200S000XXX	Tension Adapter	M-P8A	N/A	Cable Joint Kit	A-CAB-JOINTSTD
PT8000-250kg	80M0250S000XXX	Standard Mount	M-P8S	M-P8S-5		
PT8000-500kg	80M0500S000XXX	Restraining Mount	M-P8R	M-P8R-5		
		Suspension Mount - Male	M-P8H-M	M-P8H-M-5		
		Suspension Mount - Female	M-P8H-F	M-P8H-F-5		

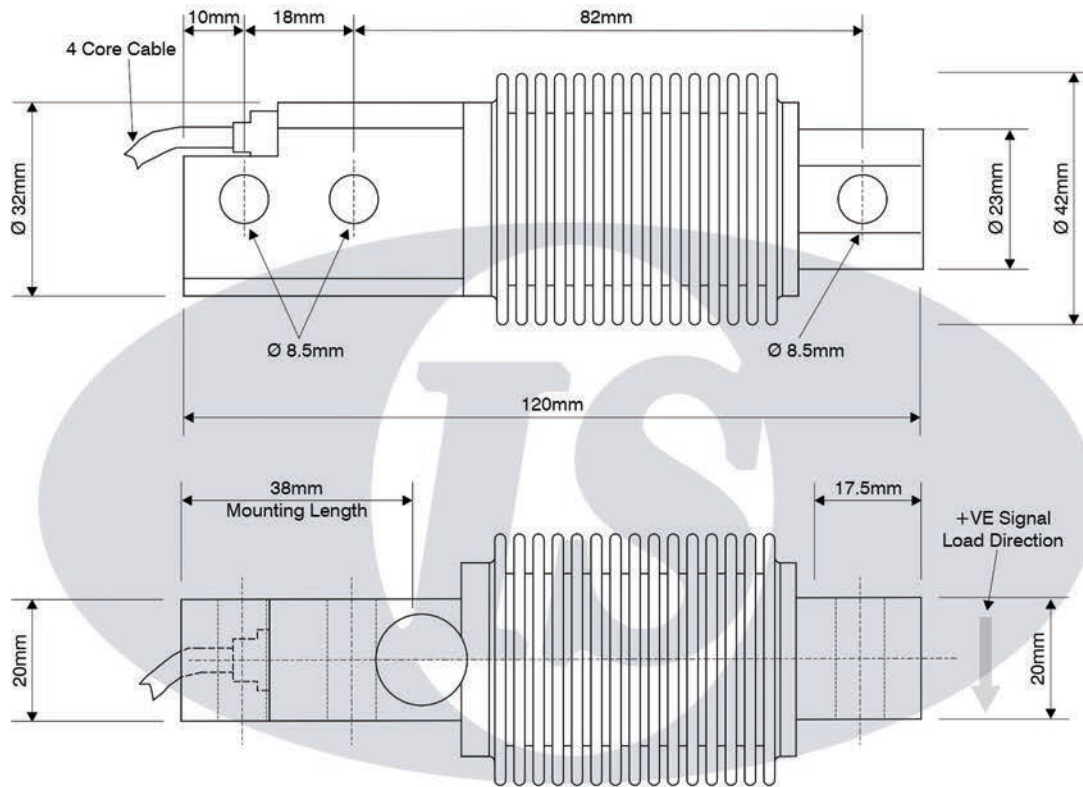

Accessories

Standard Free Motion Mount

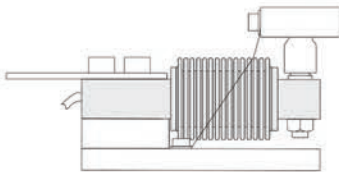

Restraining Free Motion Mount

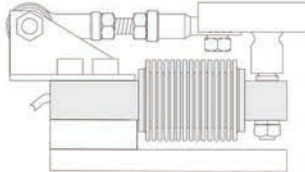

Suspension Free Motion Mount

(Male or female options available)

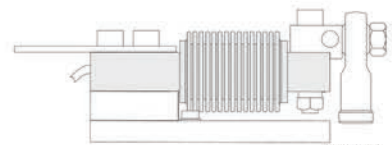

*Rod End
(Female option)*

PT Cable Colour Code

Excitation	+ve	Red
Sense	+ve	Brown
Excitation	-ve	Black
Sense	-ve	Blue
Signal	+ve	Green
Signal	-ve	White

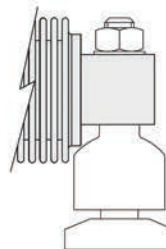

Swivel Foot

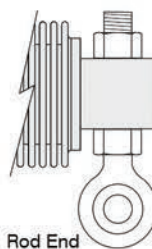

Rod End

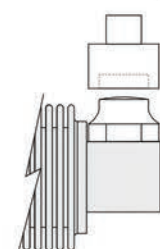

Load Socket

Load Button